

Junior

Electromechanical linear actuator for industrial applications



Linear actuators from the Junior range are diverse push-rod actuators, which are used in a wide range of machines and automated systems in the industrial sector. Due to their compact design and a number of versions, it is the ideal solution for a wide range of tasks.

● ● ● made in GERMANY

Features

- Compact design
- Maintenance-free
- Integrated limit switch
- High degree of reliability
- Versatile applications

Options

- Integrated path measuring using potentiometer
- Integrated path measuring using encoder
- Various types of cable

Mounting types

- On piston rod: articulated lug, clevis head, joint rod end, threaded bolts, spring-action articulated lug
- On housing: double lug; single lug; single lug rotated 90°

Junior overview



Contents

Junior 1	4
Junior 1s	6
Junior 2	8
Junior 2 – 230 V	10
Junior 2 MSP	12
Junior options 1; 1s; 2	14
Bearing brackets / accessories ..	15

The Junior range consists of three model sizes. In addition, there are two versions of the Junior 2 actuator, meaning there is a total of five basic types. A high level of performance makes all drives with a small build space stand out. This compact design is made possible by a motor installed in parallel to the spindle. The rotating motion of the motor is transferred via a gear onto the trapezoidal spindle. A piston rod protected against torsion runs in linear motion. The adjustable limit switches guarantee a stop at the end positions.

Junior, the versatile actuator for a wide range of applications

The Junior is the actuator which is used in a wide area of different applications, due to its three model sizes and a variety of versions and options. Thanks to its individually adjustable limit switches, it can be adapted to almost any application. Customer-specific special versions make the Junior actuator exceptional for our customers.

Junior in application

There are many possible applications for the Junior, for instance:

- Dosing facilities
- Valve and pusher motions
- Tilting devices
- Throttle adjustments to motors
- Rolling adjustments
- Flap motion
- Locking mechanisms

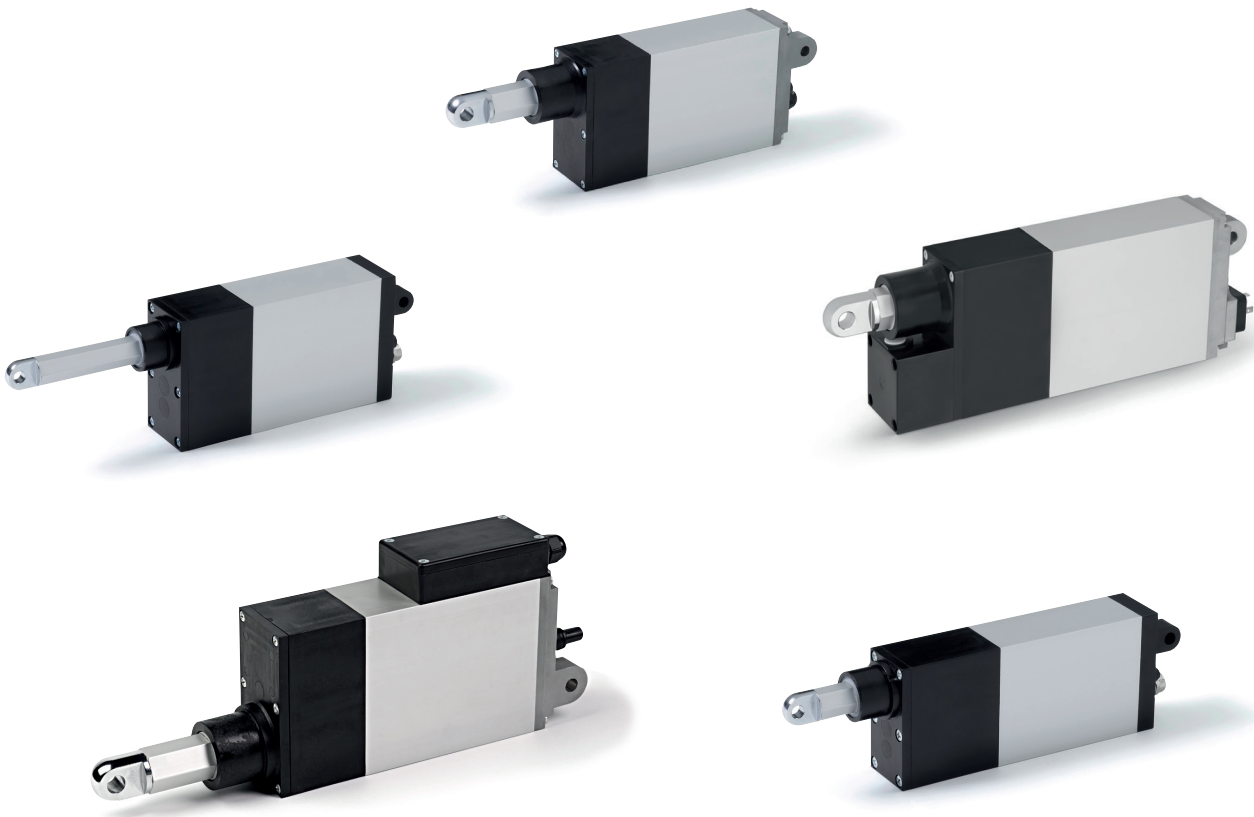

The facts

	Junior 1	Junior 1S	Junior 2 (24V)	Junior 2 (230 V)	Junior 2 MSP
Force (N)	50 – 2,000	150 – 4,000	200 – 10,000	50 – 5,000	1,000 – 10,000
Stroke speed (mm/s)	1.3 – 70	0.9 – 50	1.2 – 85	2.5 – 70	1.2 – 19
Stroke length (mm)	max. 200			max. 350	
Operating voltage	24 V DC			230 V AC	24 V DC
Voltage of the digital inputs and outputs	-				24 V DC
Duty cycle (min)	S3/40%; S3/60%; S1/100%			S2/5 min	S3/15%
Temperature range (°C)	-10 to +50				
Connecting cable length (m)	1.50				Plug-in contact
Protection class	IP 54				
Limit switches	Mechanical limit switch				
Housing	Anodised aluminium / plastic				
Overcurrent protection	No				Yes

All power performance data refers to an ambient temperature of 20 °C.

Junior 1 Compact and multifaceted

Most important features

- Light and sturdy
- Available in three voltages 12 V; 24 V; 48 V
- A variety of mounting options

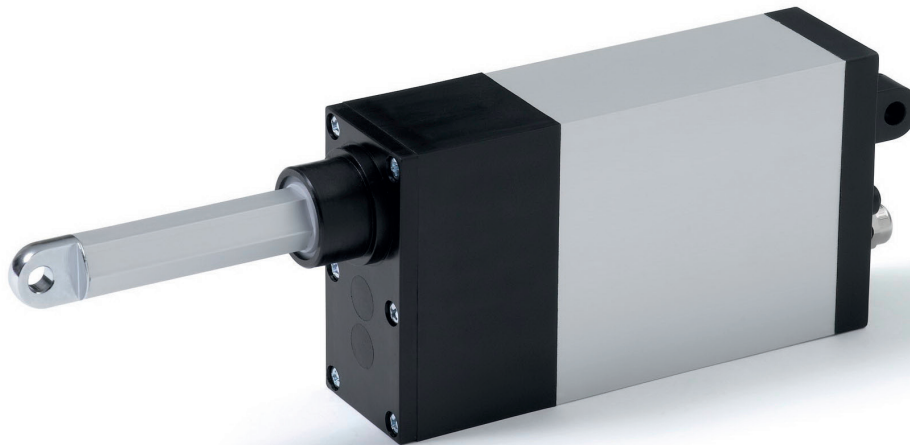

The Junior 1 is a tried and tested push-rod actuator which is used in a wide range of different applications. The Junior 1 can provide a large force, despite its incredibly compact design. It has limit switches as standard, which can directly interrupt the motor current, or be used as a unit electrically isolated from the motor.

The Junior 1 is available in 12 different versions, which cover various combinations of pushing

force, stroke speed and duty cycle. Depended on stroke lengths, three frame sizes can be manufactured.

Options

- Potentiometer
- Pulse encoder
- Fixing elements rotated 90°
- Other fixing elements upon request
- Absolute encoder

Application areas

Linear actuators in the Junior 1 series are multi-functional push-rod actuators, which are mainly used for:

- Throttle adjustments to motors
- Dosing facilities
- Track switch changing
- Tilting devices
- Flap motions
- Valve and pushing motions

Versions	ED: S3 40 %			ED: S3 60 %			ED: S1 100 %			additional planetary stages	max. stroke length
	Pushing force (N)	Stroke speed (mm/s)	Nominal current (A)	Pushing force (N)	Stroke speed (mm/s)	Nominal current (A)	Pushing force (N)	Stroke speed (mm/s)	Nominal current (A)		
A	50	55	1.2								200
B	70	30	1.2								100
C	300	15	1.2	250	17	1.1	150	20	0.8		200
D	450	8	1.2	400	9	1.1	250	10	0.8		100
E	500	10	1.2	400	13	1.1	300	15	0.8		200
F	800	5	1.2	700	6	1.1	400	7.5	0.8		100
G	1,100	4	1.2	1,000	4.5	1.1	700	5.5	0.8	•	200
H	1,600	2	1.2	1,400	2.5	1.1	1,000	2.7	0.8	•	100
I	1,400	3	1.2	1,200	3.5	1.1	900	4	0.8	•	200
J	1,700	1.5	1.2	1,400	1.7	1.1	1,200	2	0.8	•	100
K	2,000	2	1.2	2,000	2	1.1	1,500	2.6	0.8	•	200
L							2,000	1.3	0.8	•	100

All performance data refers to an operating voltage of 24VDC and an ambient temperature of 20 °C.

Dimensional drawing

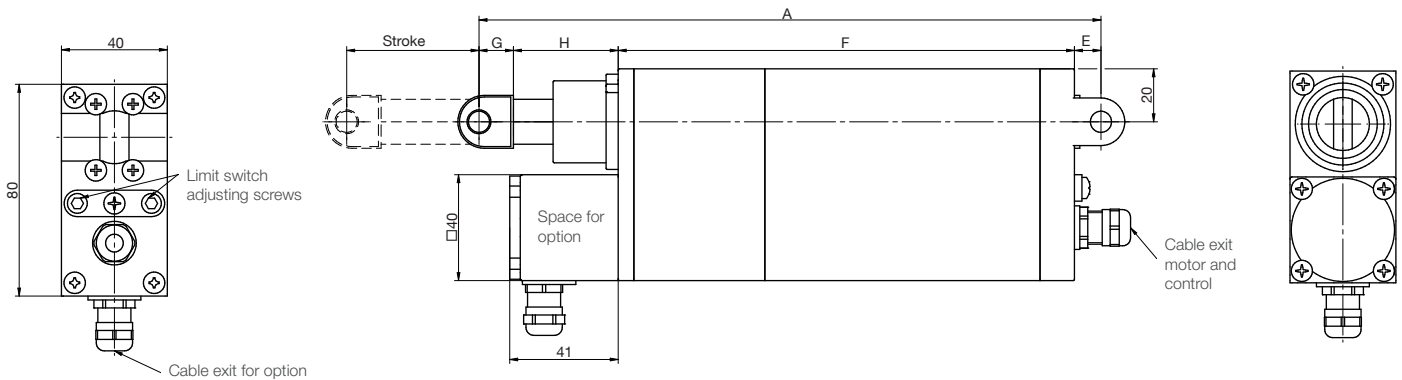

Fastening piston side – dimension G

Articulated lug Ø 8

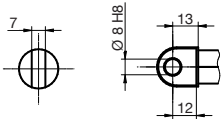

Clevis head Ø 8

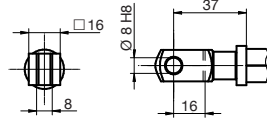

Joint rod end Ø 8

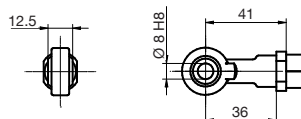

Rotatable lug Ø 8

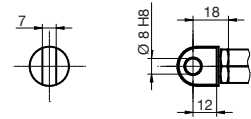

Threaded bolt M8

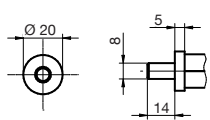

Spring-action articulated lug Ø 8 (push)

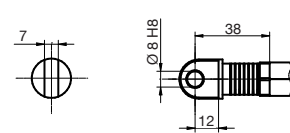

Adjustable articulated lug Ø 8

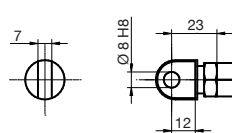

Fastening, housing side – dimension E

Double eye Ø 8

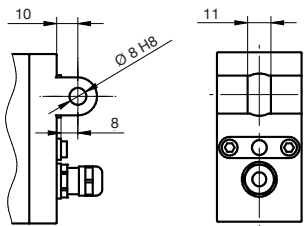

Single eye Ø 8

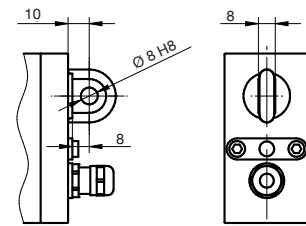

Dimension table / $A = G + H + F + E$

Stroke (mm)	Dimension H (mm)	
	Versions: A to F	Versions: G to L
100	40	27
150	90	77
200	140	127

Versions	Body dimension F (mm)
A to F	172
G to L	185

Sample calculation Junior 1

- Version E
- Stroke length 100 mm
- Fastening piston rod clevis head
- Double eye housing side

Dimension G → clevis head =	37 mm
Dimension H → Stroke length 100 mm =	40 mm
Dimension F → Stroke length 100 mm =	172 mm
Dimension E → double lug =	10 mm

Dimension A = 259 mm

Junior 1s The strong light-weight

Most important features

- Light-weight and sturdy
- Self-locking with reverse lock module
- Wide variety of mounting options



The Junior 1s is a tried and tested push-rod actuator, which is used in a wide range of different applications. The Junior 1s can provide a large force, despite its incredibly compact design. It has limit switches as standard, which can directly interrupt the motor current, or can be used as a unit electrically isolated from the motor.

The Junior 1s is available in 12 different versions, which cover various combinations of pushing force, stroke speed and duty cycle. Depending on stroke lengths, three frame sizes can be manufactured.

Reverse lock module – optionally, the Junior 1s can be fitted with a reverse lock module. This is a self-locking gear, which only provides motion direction from the motor to the spindle. A reversal in motion from the spindle to the motor is locked. This guarantees a self-locking of the actuator. The reverse lock module is only available for versions G to L. The body dimension increases with the selected option by 15 mm.

Options

- Potentiometer
- Pulse encoder
- Standardised fastening elements
- Fixing elements 90° rotated
- Other fixing elements upon request

Application areas

Linear actuators in the Junior 1s series are multi-functional piston actuators, which are mainly used for:

- Throttle adjustments to motors
- Dosing facilities
- Track switch changing
- Tilting devices
- Flap motions
- Valve and pusher motions.

Versions	ED: S3 15%			ED: S3 40%			ED: S3 60%			ED: S1 100%			Load moment locking possible	additional planetary stages	max. stroke length
	Pushing force (N)	Stroke speed (mm/s)	Nominal current (A)	Pushing force (N)	Stroke speed (mm/s)	Nominal current (A)	Pushing force (N)	Stroke speed (mm/s)	Nominal current (A)	Pushing force (N)	Stroke speed (mm/s)	Nominal current (A)			
A	150	50	2.5												200
B	280	22	2.5												100
C	1,000	11	2.5	850	12	2.0	700	13	1.8	450	14.5	1.3			200
D	1,250	5.5	2.5	1,050	6.2	2.0	900	6.5	1.8	600	7.5	1.3			100
E	1,350	7.5	2.5	1,100	9	2.0	950	9.5	1.8	700	10	1.3			200
F	1,800	3.5	2.5	1,500	4.5	2.0	1,300	4.7	1.8	800	5.3	1.3			100
G	3,500	2.5	2.5	3,200	3	2.0	2,800	3.2	1.8	2,000	3.5	1.3	•	•	200
H	4,000	1.5	2.5	3,700	1.5	2.0	3,500	1.6	1.8	2,500	1.8	1.3	•	•	100
I	4,000	2.1	1.8	4,000	2.1	1.8	4,000	2.1	1.8	2,900	2.5	1.3	•	•	150
J										4,000	1.2	1.3	•	•	100
K										4,000	1.6	1.2	•	•	150
L										4,000	0.9	1.1	•	•	100

All performance data refers to an operating voltage of 24VDC and an ambient temperature of 20 °C.

Dimensional drawing

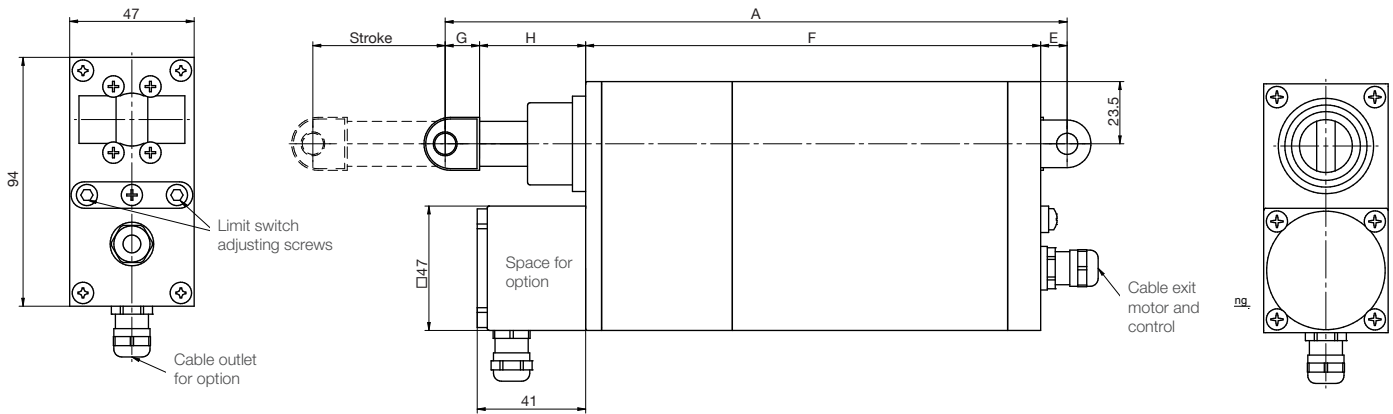

Fastening piston side – dimension G

Articulated lug Ø 8

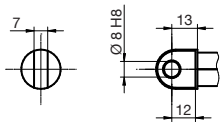

Clevis head Ø 8

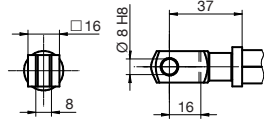

Joint rod end Ø 8

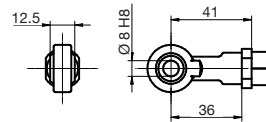

Rotatable lug Ø 8

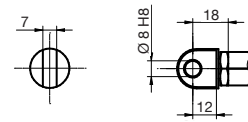

Threaded bolt M8

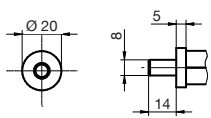

Spring-action articulated lug Ø 8 (push)

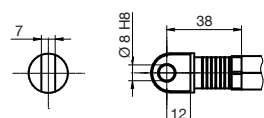

Adjustable articulated lug Ø 8

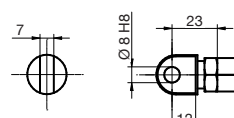

Fastening, housing side – dimension E

Double lug Ø 8

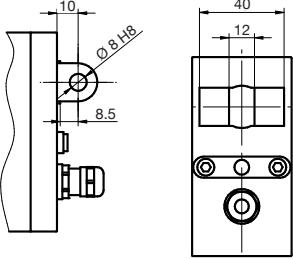

Single lug Ø 8

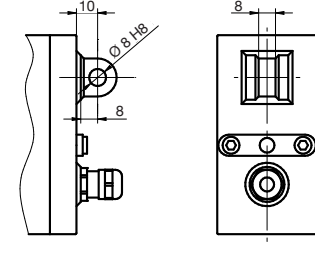

Dimension table / $A = G + H + F + E$

Stroke (mm)	Dimension H (mm)	
	Versions: A to F	Versions: G to L
100	40	25
150	90	75
200	140	125

Load moment lock	Body dimension F (mm)	
	Versions: A to F	Versions: G to L
No	172	187
Yes	-	202

Sample calculation Junior 1s

- Version E
- Stroke length 100 mm
- No reverse lock module
- Fastening piston rod clevis head
- Double lug housing side

Dimension G → clevis head =	37 mm
Dimension H → Stroke length 100 mm =	40 mm
Dimension F → Stroke length 100 mm =	172 mm
Dimension E → double lug =	10 mm

Dimension A = 259 mm

Junior 2 Our strongest Junior

Most important features

- Strongest drive from the Junior range
- Available with brake
- Optional 12 V or 48 V version
- Wide variety of mounting options



The Junior 2 is a tried and tested push-rod actuator, which is used in a wide range of different applications. With a maximum force of 10,000 N, the Junior 2 is the strongest Junior. It has limit switches as standard, which can directly interrupt the motor current, or be used as a unit electrically isolated from the motor.

The Junior 2 is available in 12 different versions, which cover various combinations of pushing force, stroke speed and duty cycle. Depending on stroke length, five frame sizes can be manufactured.

Versions A to E are supplied with brake as standard. It is a spring applied brake, which, whenever the drive moves, must be controlled. The brake ensures self-locking and additionally fast deceleration when the actuator is stopped. Other versions can also be manufactured with a brake on request. Units with brake cannot be manufactured with potentiometer or pulse encoder, as these require the same installation space.

Application areas

Linear actuators in the Junior 2 series are multi-functional push-rod actuators which are mainly used for:

- Throttle adjustments of motors
- Dosing facilities
- Track switch changing
- Tilting devices
- Flap motions
- Valve and pusher motions.

Versions	ED: S3 15%			ED: S3 40%			ED: S3 60%			ED: S1 100%			Only available with brake	additional planetary stages	max. stroke length
	Pushing force (N)	Stroke speed (mm/s)	Nominal current (A)	Pushing force (N)	Stroke speed (mm/s)	Nominal current (A)	Pushing force (N)	Stroke speed (mm/s)	Nominal current (A)	Pushing force (N)	Stroke speed (mm/s)	Nominal current (A)			
A	400	70	6.0										•		350
B	400	38	6.0										•		200
C	1,000	19	6.0	700	21	4.7	450	24	4.2	200	26	3.0	•		350
D	1,400	12	6.0	800	13	4.7	500	13.5	4.2	250	14	3.0	•		200
E	1,800	14	6.0	1,300	15	4.7	1,000	16	4.2	600	17	3.0	•		350
F	2,600	6.5	6.0	1,700	7.5	4.7	1,500	8	4.2	800	8.5	3.0			200
G	3,000	5	6.0	2,000	6	4.7	1,800	6.2	4.2	1,000	7	3.0		•	350
H	5,000	3	6.0	4,500	3.3	4.7	3,800	3.5	4.2	2,500	3.8	3.0		•	200
I	5,300	3	6.0	4,000	3.6	4.7	3,500	3.7	4.2	2,200	4.3	3.0		•	350
J	9,000	1.8	6.0	8,000	2	4.7	7,000	2.1	4.2	4,500	2.2	3.0		•	200
K	7,500	2	6.0	6,200	2.2	4.7	5,700	2.3	4.2	3,800	2.7	3.0		•	350
L	10,000	1.2	6.0	8,000	1.4	4.7	7,000	1.4	4.2	5,000	1.5	3.0		•	200

All performance data refers to an operating voltage of 24VDC and an ambient temperature of 20 °C.

Dimensional drawing

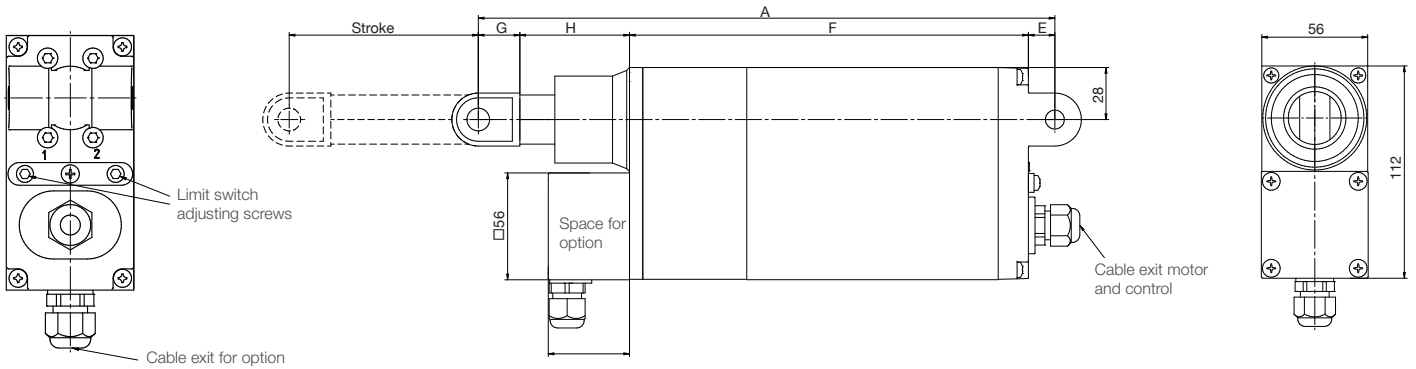

Fastening piston side – dimension G

Articulated lug Ø 12

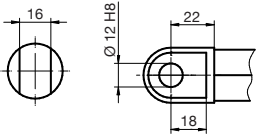

Clevis head Ø 12

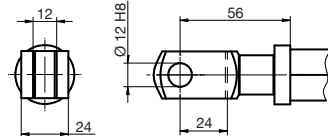

Joint rod end Ø 12

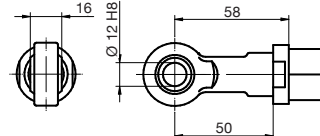

Rotatable lug Ø 12

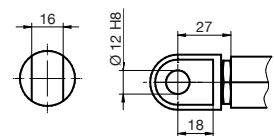

Threaded bolt M12

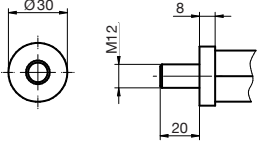

Spring-action articulated lug Ø 12 (push)

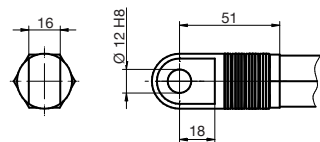

Adjustable articulated lug Ø 12

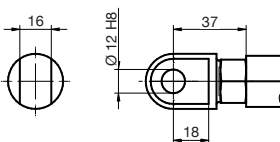

Fastening, housing side – dimension E

Double lug Ø 10

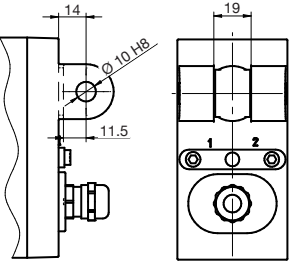

Single lug Ø 10

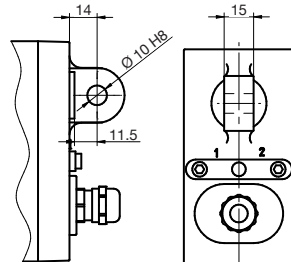

Dimension table / A = G + H + F + E

Stroke (mm)	Dimension H (mm)	
	Versions: A to F	Versions: G to L
150	58	44
200	108	94
250	158	144
300	208	194
350	258	244

Versions	Body dimension F (mm)
A to F	211
G to L	225

Sample calculation Junior 2

- Version E
- Stroke length 200 mm
- Fastening piston rod clevis head
- Double lug housing side

Dimension G → clevis head =	56 mm
Dimension H → Stroke length 200 mm =	108 mm
Dimension F → Stroke length 200 mm =	211 mm
Dimension E → double lug =	14 mm

Dimension A = 389 mm

Junior 2 – 230 V The strong AC Junior actuator

Most important features

- A strong actuator with 230 V AC motor
- Self-locking due to motor brake
- Motor capacitor integrated in the actuator
- Wide variety of mounting options

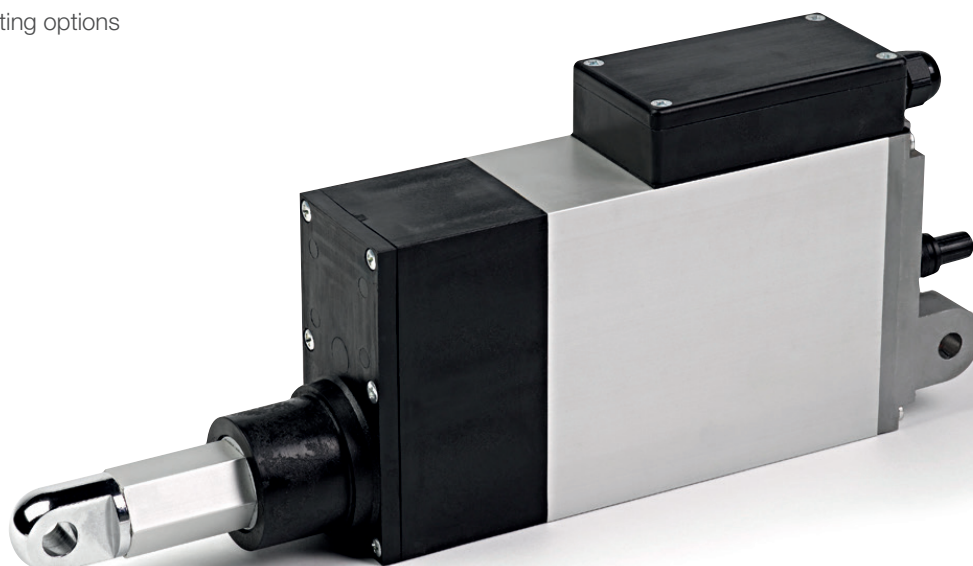

The Junior 2 230 V is a tried and tested push-rod actuator which is used in a wide range of different applications. With a maximum force of 5,000 N, the Junior 2 230 V is one of the strongest Junior actuators. It has limit switches as standard, which directly interrupt the motor current. The operating capacitor is integrated in the actuator. The armature brake integrated in the motor does not have to be controlled. It ensures fast deceleration of the actuator and self-locking at standstill.

The Junior 2 230 V is available in 6 different versions, which cover various combinations of pushing force, stroke speed and duty cycle. Depending on stroke length, five frame sizes can be manufactured.

Options

- Potentiometer
- Pulse encoder
- Fixing elements rotated 90°

Application areas

Linear actuators in the Junior 2 230 V series are multi-functional push-rod actuators which are mainly used for:

- Throttle adjustments of motors
- Dosing facilities
- Track switch changing
- Tilting devices
- Flap motions
- Valve and pusher motions.

Versions	Force (N)	Speed (mm/s)	Nominal current (A)	max. stroke
A	50	70	0.9	350
C	400	23	0.9	350
E	700	14	0.9	350
G	1,400	6.5	0.9	350
I	2,500	4	0.9	350
K	5,000	2.5	0.9	350

Duty cycle of all drives: short time operation 5 min. All performance data refers to an operating voltage of 230 V AC and an ambient temperature of 20 °C.

Dimensional drawing

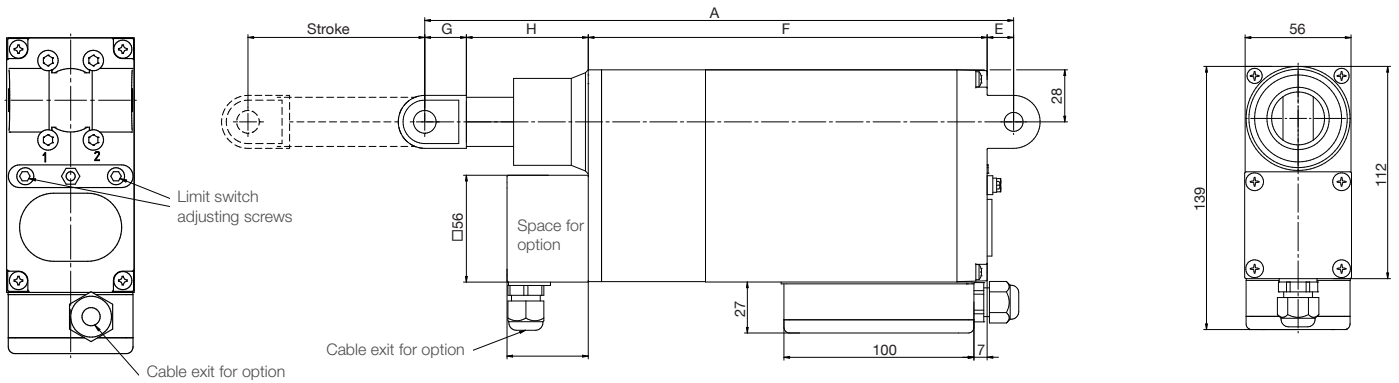

Fastening piston side – dimension G

Articulated lug Ø 12

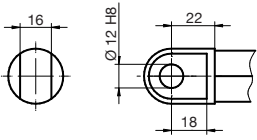

Clevis head Ø 12

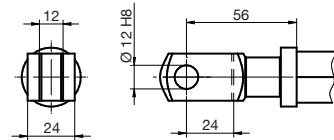

Joint rod end Ø 12

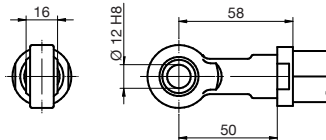

Rotatable lug Ø 12

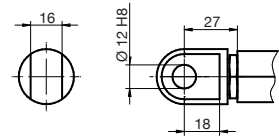

Threaded bolt M12

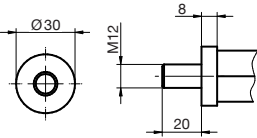

Spring-action articulated lug Ø 12 (push)

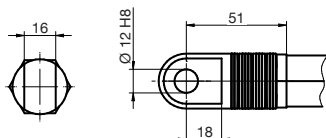

Adjustable articulated lug Ø 12

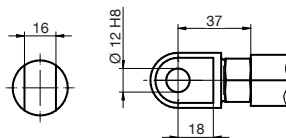

Fastening, housing side – dimension E

Double lug Ø 10

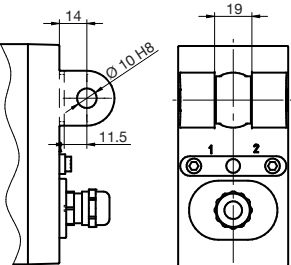

Single lug Ø 10

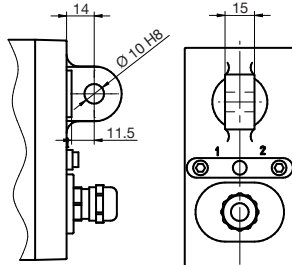

Dimension table / $A = G + H + F + E$

Stroke (mm)	Dimension H (mm)	
	Versions: A to F	Versions: G to L
150	58	44
200	108	94
250	158	144
300	208	194
350	258	244

Versions	Body dimension F (mm)
A to E	211
G to K	225

Sample calculation Junior 2 – 230 V

- Version E
- Stroke length 200 mm
- Fastening piston rod clevis head
- Double lug housing side

Dimension G → clevis head =	56 mm
Dimension H → Stroke length 200 mm =	108 mm
Dimension F → Stroke length 200 mm =	211 mm
Dimension E → double lug =	14 mm
Dimension A =	389 mm

Junior 2 MSP For direct connection to a PLC

Most important features

- Direct control via three digital inputs 24 V
- No auxiliary switching elements required
- Integrated overload protection
- Wide variety of mounting options

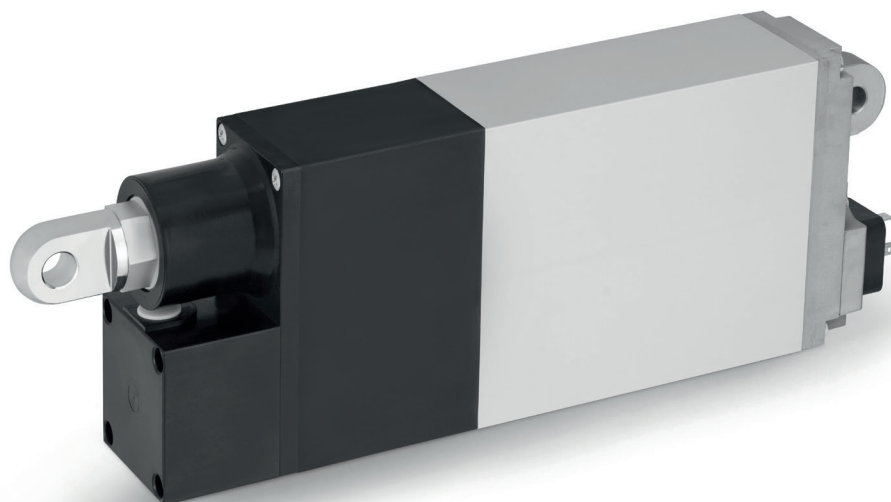

The Junior 2 MSP is an actuator which is designed for direct control by using a PLC. The motor control (MSP) is integrated in the drive, which provides evaluation of the limit switches and control of the motor. In addition, it protects the motor against overload. The start-up current is nominally restricted to 6 A. The value can be changed at the factory. Units fitted with this MSP can be operated without external circuit breaker elements, which means no additional costs for the user. The drive is controlled by using three digital 24 V PLC-compatible signal lines.

Overload protection – by setting the release and a motion direction signal, delay time “t” passes. After this the overload protection is active. If the motor current rises above I_{Max} , the motor will be disconnected from the voltage. It is only possible to restart the motor after a short switch-off of the motion direction or the enable signal.

Connection and plug assignment

- All voltage connections are protected against reversal polarity.
- The housing has no ground connections.
- The signal inputs are isolated from the supply voltage.
- For a secure connection to the output, the actuator is supplied with a maximum cable length of 10 m.

3-pin plug connector X2 (large)

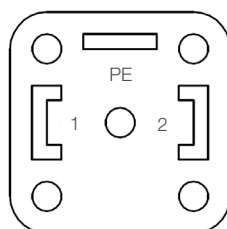

- 1 – GND
- 2 – VSS (supply voltage)
- PE – housing

4-pin plug connector X1 (small)

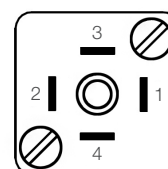

- 1 – I_{AUS} (Motion direction signal input “Extend”)
- 2 – I_{EIN} (Motion direction signal input “Retract”)
- 3 – I_{FRG} (Enable input)
- 4 – GND

Dimensional drawing

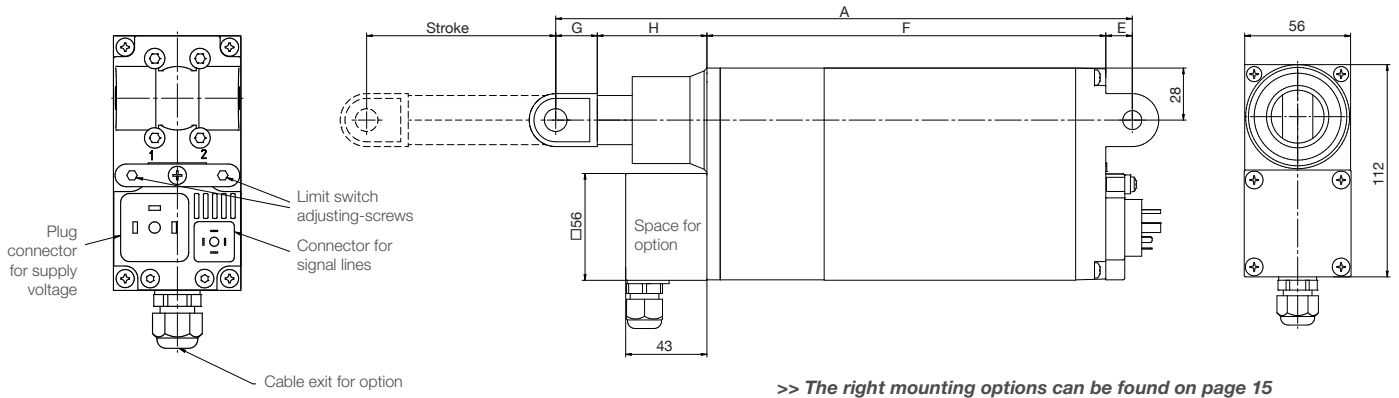

Version table

Versions	ED: S3 15 %			additional planetary gear stages	max. stroke length
	Pushing force (N)	Stroke speed (mm/s)	Nominal current (A)		
F	2,600	6.5	6.0		200
G	3,000	5	6.0	•	350
H	5,000	3	6.0	•	200
I	5,300	3	6.0	•	350
J	9,000	1.8	6.0	•	200
K	7,500	2	6.0	•	350
L	10,000	1.2	6.0	•	200

Electrical data

	Condition	min.	nom.	max.	Unit
V_{SS} (supply voltage)		18	24	32	V
I_{so} (standby current)	V _{SS} = 24 V		25		mA
Signal inputs		-30		30	V
Signal inputs 0 - signal		-30	0	8	V
Signal inputs 1 - signal		13	24	30	V
Signal inputs input current	V _{SS} = 24 V		5		mA
t_v (delay time)	V _{SS} = 24 V		120		ms
I_U (current for overload protection)*			6		A
I_{An1} (max. start-up power)*		5.8	6	6.2	A

* Values can be changed at the factory.

Input wiring

The input wiring secures the input level and input currents in accordance with PLC specification. The signal inputs are isolated from the supply voltage.

Example input wiring:

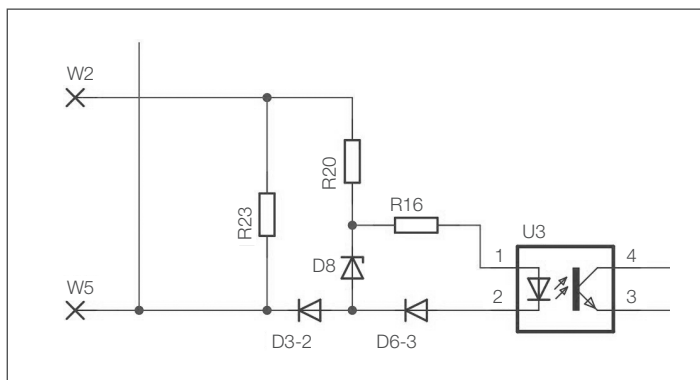

Control functions

To move the actuator, the enable and motion direction signal must be switched to high-level. By removing the enable signal, the actuator extends. With the direction signal off and activated enable input, engine is decelerated by short-circuit.

IN _{Extend}	IN _{Retract}	IN _{Enable}	Function
X1 : 1	X1 : 2	X1 : 3	
0	0	0	Motor is disconnected from voltage (roll out when stopped)
1	0	0	Motor is disconnected from voltage
0	1	0	Motor is disconnected from voltage (extend when stopped)
1	1	0	Motor is disconnected from voltage
0	0	1	Motor is short-circuited (brake when stopped)
1	0	1	Piston rod is extended
0	1	1	Piston rod is retracted
1	1	1	Motor is disconnected from voltage and not short-circuited

All performance data refers to an operating voltage of 24 VDC and an ambient temperature of 20 °C.

Options For Junior ranges 1; 1s; 2

Option 1: Potentiometer

If required, the Junior can be supplied with a potentiometer. This is a spindle potentiometer, which is connected via a gear directly with the spindle. Using the potentiometer, the absolute position of the piston rod can be determined at any time. Alternatively there is a standard potentiometer with a linearity tolerance of $\pm 0.25\%$ and a precision potentiometer with a linearity tolerance of $\pm 0.10\%$. The preferred resistance value is 10 kOhm. Other values are possible upon request.

Option 2: pulse encoder

Alternatively to the potentiometer, the Junior can also be supplied with a pulse encoder. This is connected via a gear with the spindle and emits one pulse sequence over two channels. Using a counter, a customer can determine the current position of the piston rod. Alternatively, there is a magnetic encoder with 64 pulses per turn and an optical encoder with 80 pulses per turn. Further pulse counts are available upon request.

Option 3: absolute encoder

As another possibility, the Junior 1 can be supplied with an absolute encoder, which is connected with the spindle via a gear. The position determination takes place contactless within the controller itself, using a magnetic scan. This way, the customer control is able to determine the current position of the piston rod. The output signal is 0...10 V in proportion to the built stroke length of the actuator. Additional output signals are possible upon request.

Brake Junior 2

Versions A to E of the Junior 2 actuator are supplied with an electro-mechanical spring force brake as standard. The brake is connected with a separate cable and must always be controlled when the unit is in motion. If the Junior 2 is fitted with a brake, no other options are possible, as these require the same fitting space.

Circuit diagram potentiometer

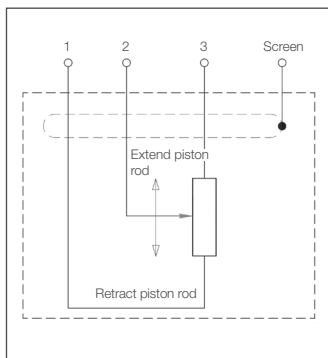

Assignment connection

Signal	Wire colour
0 V	WH
+U _e	BN
A	GN
\bar{A}	YE
B	GY
\bar{B}	PK
0	BU
$\bar{0}$	RD

Circuit diagram absolute encoder

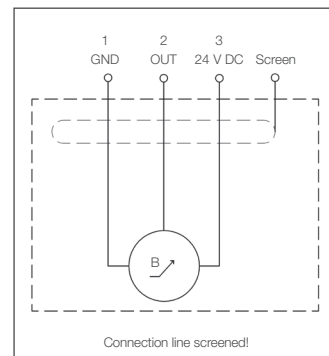

Brake / versions A to E

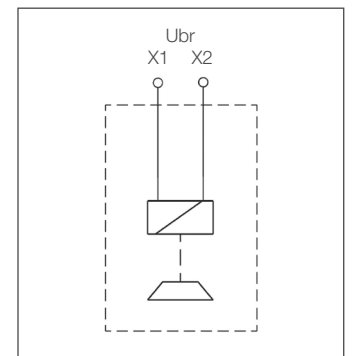

Mounting accessories Junior 1

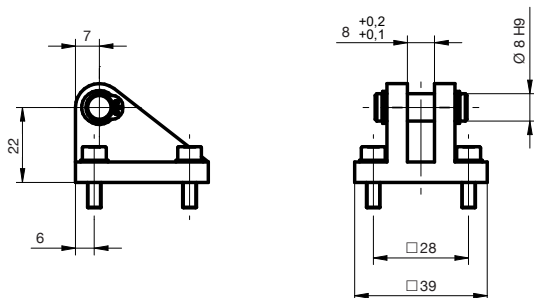

Bearing block for mounting on housing side: single lug
Art. no.: 724660101

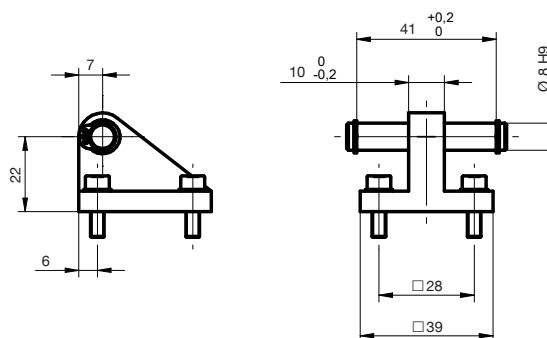

Bearing block for mounting on housing side: double lug
Art. no.: 750270101

Mounting accessories Junior 1s

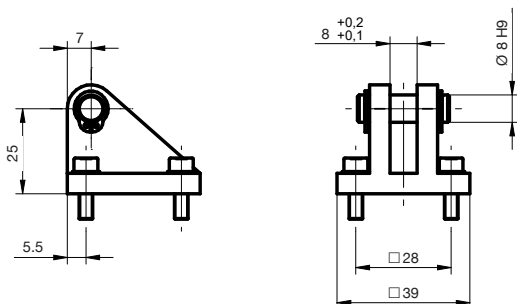

Bearing block for mounting on housing side: single lug
Art. no.: 724670101

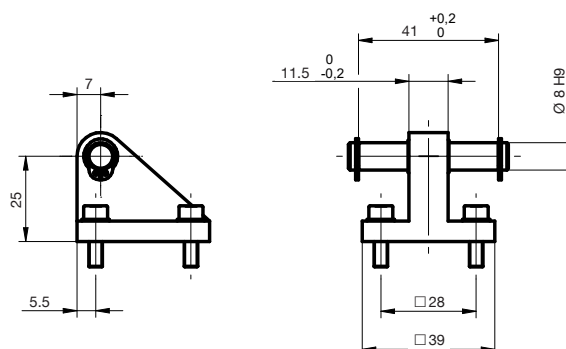

Bearing block for mounting on the housing side: double lug
Art. no.: 750270501

Mounting accessories Junior 2

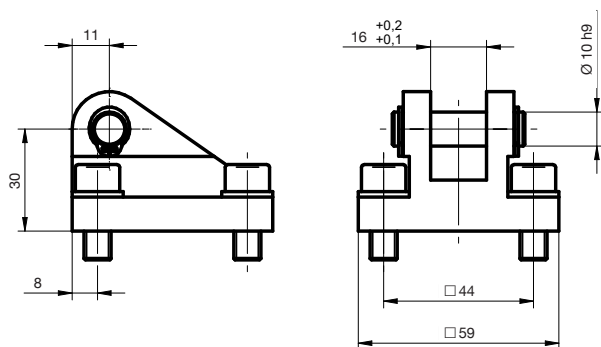

Bearing block for mounting on housing side: single lug
Art. no.: 724680101

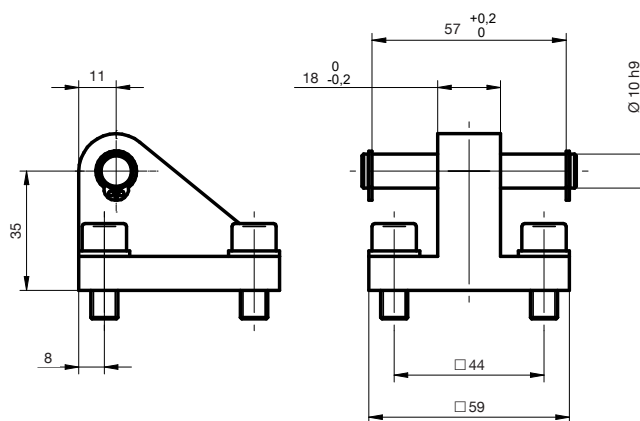

Bearing block for mounting on housing side: double lug
Art. no.: 750271701



elero GmbH
elero linear actuator technology

Naßäckerstraße 11
07381 Pößneck/Germany
T +49 3647 4607 - 0
F +49 3647 4607 - 42

info@elero-linear.com
www.elero-linear.com

You can find more technical information on our homepage www.elero-linear.com