

Kompakt with mechanical limit switch

Linear actuator

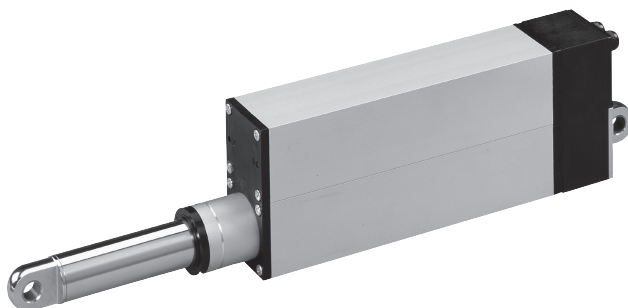

Operating instructions

Please take care of the operating instructions!



Translation from the original German version.

All other documents in different languages are translations of the original version.

Subject to change without notice. All rights reserved in the event of registration of patents, working models or design patents.

List of contents

1	General	3
1.1	Information relating to the installation instructions	3
1.2	Standards and guidelines	3
1.3	Intended use.....	3
1.4	Foreseeable misuse	4
1.5	Warranty and liability	4
1.6	Customer service of the manufacturer	5
2	Safety	6
2.1	General safety notices and directions	6
2.1.1	Formulation of the safety notices and directions	6
2.2	Safety principles	8
2.3	General duties of the plant operator	9
2.4	Requirements of the personnel	9
2.5	Safety notices and directions relating to the technical condition	10
2.6	Safety notices and directions relating to transport, assembly, installation.....	10
2.7	Safety instructions relating to operation	11
2.8	Safety notices and directions relating to the electrical installation	11
3	Product description	12
3.1	General.....	12
3.2	Product variants.....	12
3.3	Technical specifications	13
3.3.1	Summary of the technical parameters.....	13
3.3.2	Information relating to the self-locking facility	14
4	Installation	15
4.1	Mechanical fastening	16
4.2	Electrical connection.....	17
4.3	Optional attachments.....	18
4.3.1	Optional brake	18
4.3.2	Bellows option	18
4.3.3	Optional potentiometer	19
4.3.4	Optional shaft encoder	19
4.3.5	Safety nut option.....	20

List of contents

4.4	Mechanical limit switch	21
4.4.1	Permissible adjusting range of limit switches	21
4.4.2	Adjustment of limit switches	22
4.4.3	Operation of unit	23
4.5	Dimensions sheet	24
5	Declaration of incorporation	25
6	Waste disposal	26
6.1	Scrapping	26
6.2	Disposal of waste electrical and electronic components	26

1 General

1.1 Information relating to the installation instructions

The classification of the contents is based on the life stages of the linear drive (hereinafter referred to as the “device”). The manufacturer reserves the right to make changes to the technical specifications stated in these installation instructions. In detail these can differ from the respective version of the device without the factual information being fundamentally changed and without losing their validity. The current status of the technical specifications can be requested from the manufacturer at any time. Any claims arising from this cannot be asserted. Deviations from the text and pictorial statements are possible and are dependent on the technical development, equipment and accessories of the device. The manufacturer shall provide information about any differing details relating to special versions by means of the sales documentation. Other specifications shall remain unaffected by this.

1.2 Standards and guidelines

During construction the fundamental health and safety requirements were applied and provision was made for the appropriate legislation, standards, directives and guidelines. The safety element is confirmed by the Declaration of Incorporation (see section “Declaration of Incorporation”). All information relating to safety in these installation instructions refers to the laws and regulations that are currently valid in Germany. All information in these installation instructions must be complied with at all times and without limitation. In addition to the safety notices and directions in these installation instructions, the regulations applicable at the place of installation with regard to accident prevention, environmental protection and occupational safety must be observed and adhered to. The guidelines and standards for safety assessment can be found in the Declaration of Incorporation.

1.3 Intended use

The device is envisaged for use in the construction of machinery. It serves as a means of adjusting medium loads. Other fields of application must be agreed in advance with the manufacturer.

The device must not be used in areas where there is a risk of injury to personnel or in rooms in potentially explosive environments.

If a direct or indirect hazard to personnel cannot be ruled out, additional measures (e.g. covers, barriers, etc.) must be taken in order to minimise the potential risk accordingly.

The operator alone is liable for any damage arising from the non-intended use of the device. The manufacturer assumes no liability for personal injury or damage to property caused through misuse or procedural errors, improper operator control or improper start of operation.

The device must be operated only by trained and authorized skilled personnel subject to compliance with all safety notices and directions.

Safe and error-free use and operating safety of the device can only be guaranteed subject to use in compliance the intended use in accordance with the specifications set out in these installation instructions.

Intended use includes observation of and adherence to all the safety notices and directions instructions specified in these installation instructions, as well as all applicable regulations of trade associations and the valid laws in relation to environmental protection. Use in compliance with the intended use also includes adherence to the operating regulations prescribed in these installation instructions.

1.4 Foreseeable misuse

Any installation into other equipment that deviates from the purpose cleared by the manufacture applies as being a foreseeable misuse.

1.5 Warranty and liability

In principle, the General Terms & Conditions of Sale and Delivery of the manufacturer apply. The Terms & Conditions of Sale and Delivery are a component part of the sales documentation and are handed over to the plant operator at the time of delivery. Liability claims for personal injury and damage to property are excluded, if they are attributable to one or several of the following causes:

- Opening of the device by the customer (breaking the seal)
- Use not in compliance with the intended use of the device
- Improper installation, start of operation or operator control of the device
- Changes to the design and construction of the device without the written approval of manufacturer
- Operation of the device with improperly installed connections and defective or improperly attached safety and protection devices

- Non-compliance with the safety stipulations, notices and directions provided in these installation instructions
- Exceeding of the specified technical specifications

1.6 Customer service of the manufacturer

The device may be repaired only by the manufacturer in the event of a fault. The address for sending in the device to the customer service department can be found on the inside of the back cover.

If you have not purchased the device directly from elero, please contact the manufacturer of the machine or the supplier of the device.

Mechanically secure the machine before dismantling the device.

The device must not be separated from the machine by force.



The serial number must be at hand, if you request customer service. This can be found in the top right-hand half of the type plate.

2 Safety



2.1 General safety notices and directions

These installation instructions contain all the safety notices and directions that must be observed in order to avoid and prevent dangers when working with the device in the individual life cycles. Safe use of the device is guaranteed when all the specified safety notices and directions are complied with.



2.1.1 Formulation of the safety notices and directions

The safety notices and directions in this document are marked with safety symbols and formulated in accordance with the SAFE principle. They contain specifications relating to the type and source of danger, the possible consequences, as well as the prevention of the danger.



The following table defines the representation and description of the levels of danger with possible physical injury, as used in these installation instructions.

Symbol	Keyword	Meaning
	DANGER	Warns of an accident that will occur if the instructions are not followed, which can lead to life-threatening, irreversible injuries or death.
	WARNING	Warns of an accident that may occur, if the instructions are not followed, which can lead to serious, perhaps life-threatening, irreversible injuries or death.
	CAUTION	Warns of an accident that can occur, if the instructions are not followed, which can lead to minor, reversible injuries.

The following table describes the symbols used in these installation instructions for the graphic display of danger situations in connection with the symbol for the danger level.

Symbol	Meaning
	Danger due to an electrical voltage, electric shock: This symbol refers to dangers associated with electrical currents.
	Danger of crushing and killing people: This symbol refers to dangers due to which the entire body or individual limbs can become crushed or injured.

The following table defines the representation and description used in the installation instructions for situations in which damage can occur to the product or draws attention to important facts, statuses, tips and information.

Symbol	Keyword	Meaning
	<i>CAUTION</i>	This symbol warns of possible damage to property.
		This symbol draws attention to important facts and statuses, as well as to further information in these installation instructions. Furthermore, it refers to specific instructions which give additional information on or provide assistance in how to perform a procedure more easily.

The following is an example of the structure of a safety notice:



DANGER

Type and source of danger

Explanation of the type and source of danger

- Measures to avert danger.

2.2 Safety principles

The device is built according to state-of-the-art technology and the generally accepted rules of safety and it is safe to operate. The basic safety and health requirements of the applicable laws, standards, directives and guidelines have been applied in the construction of the device. The safety of the device is confirmed by the Declaration of Incorporation.

All specifications pertaining to safety relate to the currently valid regulations of the European Union. In other countries it must be ensured by the plant operator that the applicable laws and national regulations are complied with.

In addition to the safety notices and directions in these installation instructions, the generally applicable regulations regarding accident prevention and environmental protection must be observed and complied with.

The device must only be used when in perfect working order, for its intended use, and in compliance with the safety notices and directions in these installation instructions. The device is designed for the application in accordance with the section "Intended use". In the event of use that is not in compliance with the intended use, injury to the life and limb of the user or third parties or impairments to the device and other property can arise. Any accidents or almost accidents during the use of the device that lead to or could have led to personal injuries and/or damage in the working environment must be reported directly and without delay to the manufacturer.

All safety notices and directions specified in the installation instructions and on the device must be adhered to. In addition to these safety notices and directions, the operator must ensure that all national and international regulations applicable in the respective country of use, as well as other binding regulations relating to operational safety, accident prevention and environmental protection are complied with. All work on the device must be performed only by trained, safety instructed and authorized personnel.

2.3 General duties of the plant operator

- ❑ The plant operator is obligated to use the device only in perfect and operationally safe condition. He must ensure that, in addition to the safety notices and directions in the installation instructions, the generally accepted safety and accident prevention regulations, the specifications of DIN VDE 0100 and the provisions relating to environmental protection of the respective country of use, are heeded and complied with.
- ❑ The plant operator is responsible that all work with the device is performed only by trained, safety instructed and authorized personnel.
- ❑ Ultimately responsible for accident-free operation is the plant operator of the device or the personnel authorized by the plant operator.
- ❑ The plant operator is responsible for compliance with the technical specifications, in particular for compliance with the static loads.

Non-compliance with the static loads may cause loss of the support or holding function.

2.4 Requirements of the personnel

- ❑ Each person who is charged with performing work on the device must have read and understood the complete operating instructions before he performs the corresponding work. This also applies, if the relevant person has previously worked with such a device or was trained to do so.
- ❑ All work on the device must be performed only by trained, safety instructed and authorized personnel. Prior to the commencement of all activities the personnel must have been made familiar with the dangers that exist while handling the device.
- ❑ All personnel may perform only work that is in accordance with their qualifications. The areas of responsibility of the respective personnel must be clearly defined.
- ❑ Any personnel charged with working with the device must have no physical limitations that temporarily or permanently restrict their attentiveness or judgement (e.g. due to overtiredness).
- ❑ Minors or persons who are under the influence of alcohol, drugs or medication are prohibited from working with the device, as well as performing any installation, dismantling or cleaning work.
- ❑ Personnel must wear suitable personal protective equipment appropriate to the work incurred and prevailing working environments.

2.5 Safety notices and directions relating to the technical condition

- The device must be checked before installation for damage and proper condition.
- The plant operator is obligated to operate the device only in perfect and operationally safe condition. The technical condition must comply with the legal requirements at all times.
- If dangers to personnel or changes in operating behaviour are recognized, the device must be shut down immediately and the incident reported to your superiors or to the plant operator.
- The device may only be connected to the energy supply intended and designed for this purpose. Please refer to the type plate for the permissible type of voltage and operating voltage.
- No changes, attachments or conversions may be performed on the device without the authorization of the manufacturer.
- If wear is detected on the trapezoidal or ball screw spindle or on the spindle nut, the device must be brought to the manufacturer for maintenance.

2.6 Safety notices and directions relating to transport, assembly, installation

The relevant transport company is fundamentally responsible for the transport of the device. The following safety requirements must be complied with during transport, erection and installation of the device.

- During transport the device has to be secured in accordance with the regulations of the auxiliary transport means being used.
- For transport only hoist and slings may be used that are dimensioned so that they can safely bear the forces that occur during loading, unloading and installation of the device.
- Only the points defined on the pallet and device are allowed to be used as lifting and hoisting points:
- If work is required on lifted parts or work devices, these must be secured against falling by means of suitable devices. Work equipment for the lifting of loads must prevent loads from shifting unintentionally, falling unhindered and unhooking unintentionally.
- Standing under suspended loads is prohibited.
- A hard hat must be worn during loading work with hoists.
- The erection and installation work may be performed fundamentally only by trained and instructed skilled personnel.

2.7 Safety instructions relating to operation

- The operator of the device is obligated to ensure the safe and proper state of the device before the initial start of operation.
- This is also necessary during operation of the device at regular intervals to be determined by the plant operator.
- In the event of a fault, misuse and/or if control components are not connected correctly, this can cause the supporting and retaining function of the device to be impaired.
- No radial and/or torsional forces must be allowed to act on the device.

2.8 Safety notices and directions relating to the electrical installation

- All work on the electrical system must be performed only by authorized skilled electricians in accordance with the applicable rules and stipulations of the trade association, in particular the stipulations of DIN VDE 0100. Furthermore, the national statutory regulations of the respective country of use must be observed.
- In the event of any defects, such as loose connections or defective or damaged cables, the device must not be put into operation.
- In the event of faults with the electrical equipment, the device must be switched off immediately.
- The device must be switched off to de-energized before any inspection, installation or dismantling work.
- The device must not be hosed down with a high-pressure cleaner or steam jet.

The following must be checked before connecting the device to the power supply:

- Are all electrical connections, safety devices, fuses, etc. properly installed, connected and earthed?
- Is the power connection provided in accordance with the specifications in the electrical circuit diagram (voltage type, voltage level)?
- Has the supply line been de-energized?

3 Product description

3.1 General

The device is an electromechanical linear drive. It performs linear movements.



Fig. 1 Components of the device

- 1 Fastening on piston side
- 2 Limit switch setting screws
- 3 Housing cover
- 4 Connection cable
- 5 Fastening on housing side

3.2 Product variants

The device can be obtained in various configurations.

You can refer to the order confirmation for the exact configuration of your device.

3.3 Technical specifications



All information in this section relates to an ambient temperature of 20°C.

3.3.1 Summary of the technical parameters

Technical specifications	Kompakt	
Rated voltage	400 V 3 AC, 50 Hz or 24 V DC	
Force, dynamic	up to 15,000 N	
Force, static	up to 15,000 N	
Stroke speed	approx. 1.5 mm/s to 65 mm/s	
Stroke length	up to 1000 mm	
Rated current	up to 1.3 A with AC ¹⁾	up to 10 A with DC ¹⁾
Power	up to 900 VA with AC	up to 240 W with DC
Duty cycle	See data plate	
Length of the control and connection cables	1.50 m ²⁾	
Protection class	IP 54	
Operating temperature range	- 10 °C to + 50 °C	
Airborne noise emission	> 70 dB (A) ³⁾	
Weight	up to 20 kg	

Tab. 1 Technical parameters

- 1) If voltage surge protection devices are used, the exact current draw of the unit must be calculated prior to installation.
- 2) Depending on customer requirement, between 1.5 m and 10.0 m on AC version and between 1.5 m and 5 m on DC version possible.
- 3) 1 m distance; 1.6 m above unit; nominal operation; measuring tolerance 10 %



You can refer to the type plate for the variant-dependent values of your device.

3.3.2 Information relating to the self-locking facility



WARNING

Danger of injury through loss of the self-locking facility.

Crushing and fatal injuries are possible.

- Use device with a brake.



CAUTION

Possible damage to the device or customer's machine through loss of the self-locking facility.

- Use device with a brake.

With the devices it is differentiated between dynamic and static self-locking. Dynamic self-locking arises from movement and static self-locking when the device is at a standstill. The self locking facility on the devices is dependent on various factors, e.g.:

- Flight angle of the spindle and nut
- Surface roughness of the flanks of the spindle and nut
- Running speed

The self-locking facility can be negatively influenced by a multitude of factors, e.g. by:

- Shocks and vibrations
- Loads
- Heating

A theoretically self-locking spindle is no replacement for a brake. For this reason the assumption of any warranty obligations relating to self-locking is excluded.

Self-locking is NOT for the purpose of fulfilling any safety-related properties.

In order to minimize any further dangers, observe the duty of care that is normal for technical products.

4 Installation



WARNING

Danger of injury due to weathering influences.

The skin may suffer frostbite or burns.

- Wear personal protective equipment.
-



WARNING

Danger of injury due to incorrectly dimensioned mountings.

Crushing and fatal injuries are possible.



- Use only fastening materials that are suitable for the dimensions of the mountings.
 - The counter-mountings (provided by customer) must be rated at least for the forces for which the device was designed.
-



WARNING

Danger of injury through loss of the support and holding function.

Crushing and fatal injuries are possible.



- Pay attention to static loads.
-



WARNING

Danger of injury due to electric current.

Electric shock possible.



- Have any electric work performed only by an authorized skilled electrician.
-



WARNING

Danger of life-threatening injury due to faulty electrical connection.

Electric shock possible.



- Check the proper connection of the PE conductor prior to initial start of operation.
-



CAUTION

Damage to the device due to radial and/or torsional forces.

- No radial and/or torsional forces must be allowed to act on the device.
-



CAUTION

Damage to the device due to the connecting rod jamming.

- The linear path of the piston must be freely moveable at all times.
 - The pivoting range of the device must be kept free.
-



CAUTION

Damage to the device due to loss of the support and holding function.

- Pay attention to static loads.
-



The device was manufactured with the circuit diagram ordered by you. The designation can be found in the sales documentation or the circuit diagram enclosed with the delivery.



In delivery condition (factory setting), the connecting rod is already slightly extended. Please refer to the sales documents for the minimum and maximum dimensions.

4.1 Mechanical fastening



CAUTION

Damage to the device due to radial and/or torsional forces.

- No radial and/or torsional forces must be allowed to act on the device.
-



CAUTION

Damage to the electrical leads due to crushing or a tensile load.

- All electrical leads have to be laid so that they are not exposed to any crushing or tensile loads.
-

Fasten the device only by the fastening elements provided for this purpose. These are located at the end of the housing and on the piston rod.

4.2 Electrical connection



WARNING

Danger of life-threatening injury due to faulty electrical connection.

Electric shock possible.



- Check the proper connection of the PE conductor prior to initial start of operation.
-



CAUTION

Damage to the device due to faulty electrical connection.

- Take note that the motor and control unit have different supply voltages.
-



CAUTION

Damage to the device due to mishandling.

- Operation must not take place without integration into and evaluation of the limit switches in the control unit.
-



CAUTION

Damage to unit for versions with 400 V 3 AC caused by faulty electrical connection.

- Always connect the monitor cable to a right-hand rotary field.
-



CAUTION

Damage to the device due to the use of a non-fitting or unsuitable drive control unit.

- The control unit must support all the options attached to the device.
 - Connect all the marked cable conductors.
 - Do not connect any conductors that are not marked.
-

No circuit diagrams are listed below on account of the multitude of configuration possibilities.

The device has to be connected in accordance with the circuit diagram enclosed with the delivery.

Please refer to the following pages or the circuit diagram enclosed with the delivery for connection of the option selected by you.

4.3 Optional attachments

4.3.1 Optional brake



CAUTION

Damage to the device due to incorrect connection of the brake.

- Operate the device only when the brake is released.
 - Do not tap the brake voltage parallel to the motor.
-

With the integrated brake you can decelerate the stroke movement of the connecting rod faster and optimize the static safety.

To release the brake, connect the brake coil with conductor codes X1 and X2 to the rated voltage of the brake in accordance with the type plate.

The braking effect does not set in until the operating voltage is missing at X1 and X2.

4.3.2 Bellows option

To assure permanent and trouble-free use of the bellows, the following must be observed.



CAUTION

Damage to bellows

- Do not allow sharp edges to come into contact with bellows.
 - Do not pinch creases of bellows during operation.
 - Do not place bellows on moving machinery.
-

In the event of very long, horizontally positioned bellows, it is recommended to suspend the bellows suitably in order to prevent any sagging and wear on the piston rod.

To prevent any pressure building up on the inside of the bellows, a tongue-shaped cut or a small hole should be made at the corresponding point in a bellows crease.

4.3.3 Optional potentiometer



CAUTION

Damage to the device as a result of overstepping of power of the potentiometer.

- The potentiometer can be loaded to max. 0.5 W.
- The maximum contact current is 35 mA.
- The potentiometer may only be operated with direct current (DC).

The integrated potentiometer supplies information about the movement and current position of the piston rod.

The potentiometer requires a separate voltage supply.

The resistance between connections 1 and 2 increases synchronously with ejection of the piston rod.



The screening must be applied by the customer.

4.3.4 Optional shaft encoder

The integrated shaft encoder supplies information about the movement of the connecting rod. Please refer to the following table for the parameters necessary for operation.

Electrical parameters	
Output switching	Push-pull
Rated voltage (U_B)	5 – 24 V DC
Current consumption (no load)	max. 50 mA
Permissible load per channel	max. 50 mA
Signal level high	min. $U_B - 2.5$ V
Signal level low	max. 0.5 V
Rise time t_r	max. 1 μ s
Fall time t_f	max. 1 μ s
Short-circuit resistant outputs	Yes
CE conformity in compliance with EN 50081-2 and EN 55011 class B	

Tab. 2 Electrical parameters of the shaft encoder

Installation

Signal	0 V	+U _B	A	\bar{A}	B	\bar{B}	0	$\bar{0}$
Conductor colour	WH	BN	GN	YE	GY	PK	BU	RD

Tab. 3 Connection assignment of the shaft encoder



All unused conductors have to be insulated before start of operation.



The screening must be applied by the customer.

4.3.5 Safety nut option



WARNING

Danger of injury through loss of the support and holding function.

Persons may be crushed and killed.



- Operation with the device with supporting safety nut must be stopped.
- After activation of the supporting function of the safety nut, the device must be shut down immediately.

A safety nut is used, in particular, where damage could result following a breakage of the supporting thread.

If the thread turns in the supporting nut fail (e.g. wear limit exceeded), the safety nut takes over the support and holding function.

Device operation must not continue in this state because the safety nut is also subject to natural wear.

We recommend therefore that the wear status be checked at regular intervals, e.g. after 8000 m operational performance of the device (Kompakt 15 kN pull-push load with observance of all technical parameters) by the manufacturer to prevent hazardous situations.



Engagement of the safety nut can be indicated by squeaking of the device, a sudden change in the end limit position or running of the motor without a stroke movement.



Devices with safety nuts are classified as low-maintenance because a check should take place after the above-mentioned operational performance.

4.4 Mechanical limit switch



To adjust the limit switch, a suitable wrench is required (size 4).

4.4.1 Permissible adjusting range of limit switches



CAUTION

Risk of damage to unit by exceeding permissible range of adjustment.

- The "retracted" and "ejected" limit switches must not be adjusted any more than 10 mm in the direction of stroke reduction.

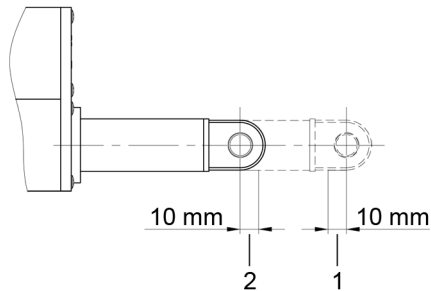

Fig. 2 Permissible stroke reduction

- 1 Stroke reduction ejected
- 2 Stroke reduction retracted

4.4.2 Adjustment of limit switches



CAUTION

Risk of damage to unit by incorrect limit switch adjustment.

- Before adjusting the limit switches, the piston rod must be moved several centimetres away from the position to be set.

Factory setting:

The limit switches have been preset to the dimensions defined in the order confirmation.

If any other dimensions are required, proceed as described below.

The two setting screws are located on the housing cover.



Even the smallest turn of the limit switch setting can result in considerable changes to the stroke depending on the ratio.

1. Move the piston rod a few centimetres away from the targeted limit switch position.
2. Adjust the limit switch (+/-).
3. Move the drive back to the limit switch.
4. Repeat the process until the desired dimension is reached.

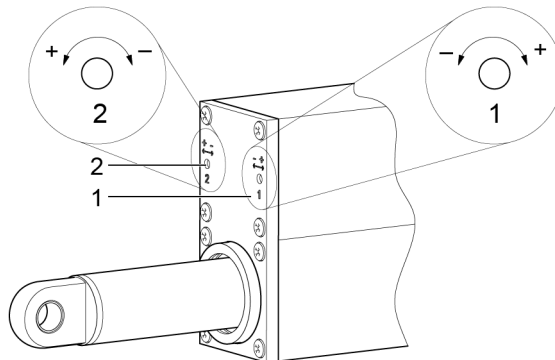

Fig. 3 Housing cover with setting screws

- 1 Setting screw 1 (limit position "piston ejected")
- 2 Setting screw 2 (limit position "piston retracted")

Adjustment of limit switch "ejected" (setting screw 1)

Stroke reduction:	Turn in direction of "-" MINUS	Limit switch position is moved in direction of "retracted". (Piston rod ejects less notably)
Stroke reduction:	Turn in direction of "+" PLUS	Limit switch position is moved in direction of "ejected". (Piston rod ejects further)

Tab. 4 Adjust setting screw 1

Adjustment of limit switch "retracted" (setting screw 2)

Stroke reduction:	Turn in direction of "-" MINUS	Limit switch position is moved in direction of "ejected". (Piston rod retracts less notably)
Stroke reduction:	Turn in direction of "+" PLUS	Limit switch position is moved in direction of "retracted". (Piston rod retracts further)

Tab. 5 Adjust setting screw 2

4.4.3 Operation of unit



CAUTION

Damage to the device due to wrong operation.

- The thermal protection switch must not be used as a regular overload switching device.
- Fast polarity reversal of the traversing direction of the drive is not permissible.
- The drive must come to a complete standstill before changing the direction of movement.

4.5 Dimensions sheet

On account of the multitude of configuration possibilities no dimensions sheets are listed below.

You can request from the manufacturer an exact dimensions sheet for the device supplied, if required.

5 Declaration of incorporation



The complete declaration of incorporation can be downloaded from our website:
www.elero-linear.de/downloads.

6 Waste disposal

6.1 Scrapping

When scrapping the device, comply with the internationally, nationally and regionally specific laws and regulations valid at that point in time.



Ensure that the recycling capability, dismantling capability and separation capability of the materials and subassemblies as well as the environmental and health dangers are all taken into consideration for the recycling and waste disposal.

Material groups, such as plastics and metals of different types, must be sorted before submitting to the recycling and waste disposal process.

6.2 Disposal of waste electrical and electronic components

The disposal and recycling of waste electrical and electronic components must take place in compliance with the relevant laws and national regulations.

elero GmbH

Naßäckerstraße 11

07381 Pöbneck

Germany

T +49 3647 46 07-0

F +49 3647 46 07-42

info@elero-linear.de

www.elero-linear.com